



DUNAVOX
THE WINE COOLING EXPERT

DUNAVOX AROUND THE WORLD



MORE THAN
40
COUNTRIES AROUND THE WORLD

MORE THAN
100
MODELS

6
PRODUCT FAMILIES

A VISION OF GLOBAL REACH

For almost twenty years, the award winning wine cooler brand, Dunavox, has been associated with professional storage and cooling solutions for wine at home – Dunavox has been at the forefront of development and is known for minimalistic yet functional design character, practical internal layout, state-of-the art technology and energy efficiency.

As a result of recent further business expansion, Europe's largest range of over 50 different premium wine coolers is now available through it's network of global distributors but also five separate Dunavox subsidiaries – all providing high quality assistance, technical support and after-sales service.

DUNAVOX Kft., Hungary

1131 Budapest, Rokolya utca 1-13.
Phone: +36 1 270 5904
Email: info@dunavox.com

DUNAVOX Deutschland GmbH, Germany

84056 Rottenburg Dieselstrasse 34
Phone: +49 8781 760 4999
Email: deutschland@dunavox.com

DUNAVOX Benelux B.V., The Netherlands

Postbus 13251, 3507 LG, Utrecht
Phone: +31 0 307430230
Email: nederland@dunavox.com, belgie@dunavox.com

DUNAVOX Italia s.r.l, Italy

31031 Caerano di San Marco
Phone: +39 0423 650022
Email: info@dunavox.it

DUNAVOX GB Ltd., The United Kingdom

CH1 4EB Chester Unit 4 Hunters Walk
Phone: 0333 577 6466
Email: sales.gb@dunavox.com

DUNAVOX Iberia sl, Spain

08400 Granollers-Barcelona, C/ Pallars 6, planta 7ª
Phone: +34 938 700 895
Email: iberia@dunavox.com



PROFESSIONAL WINE STORAGE



OWN A WINE CELLAR AT HOME

Dunavox wine coolers are designed to mimic a wine cellar, the features that occur naturally in a wine cellar are all managed and maintained within a Dunavox wine cooler. There is a balance of light, temperature and humidity, where your wine collection can be stored in peace. Wine cellars are difficult to incorporate into existing houses and are generally found in the basement, this means that a Dunavox wine cooler is the perfect solution to store all your wines safely and for many years to come.



PERFECT GET-TOGETHER AT HOME



BE A WINE CONNOISSEUR

Entertaining at home and experimenting in the kitchen with special ingredients and complex recipes have become a lot more popular than ever before giving quality wine drinking more significance. And there surely is nothing better than sipping on a glass of wine that has been served in the correct glass and chilled to perfection and aged appropriately.



INSPIRATION TO YOUR HOME

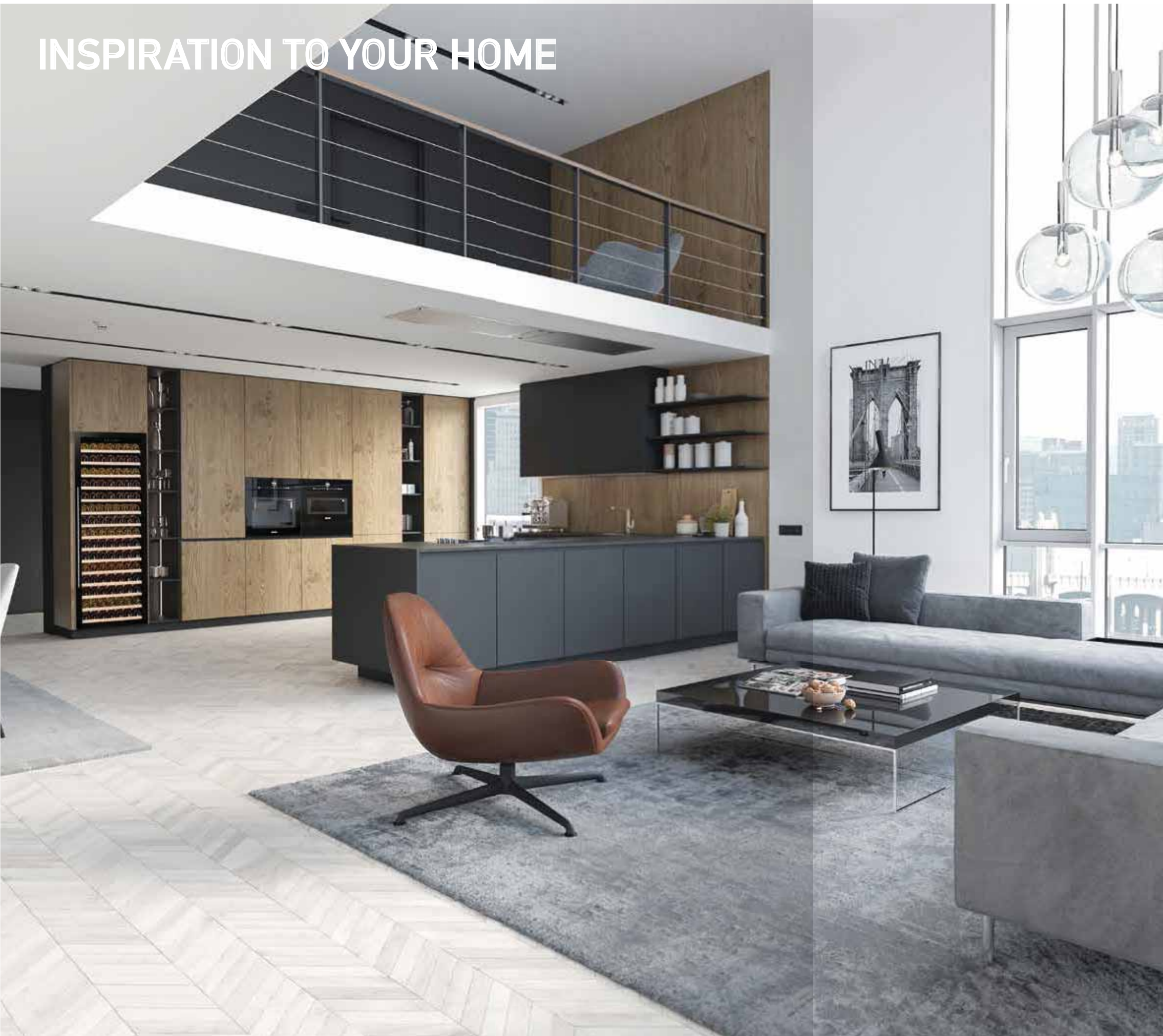

OWN A WINE CELLAR AT HOME

Ever been amazed how a wine cooler can create such a dynamic space, offering numerous possibilities in terms of design and finish? It is almost like painting on a canvas where you can give wings to your imagination. You surely don't want it look alien from the entire design of your home. Rather, the look and feel should be like it is an integral part of your interior designing scheme. One of the biggest advantages of having a wine cooler that it makes your interior luxurious and sophisticated at the same time. It takes the place of pride in the middle of the living area and creates an undeniable statement of luxury and class.



DUNAVOX PREMIUM SOLUTIONS

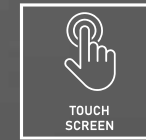
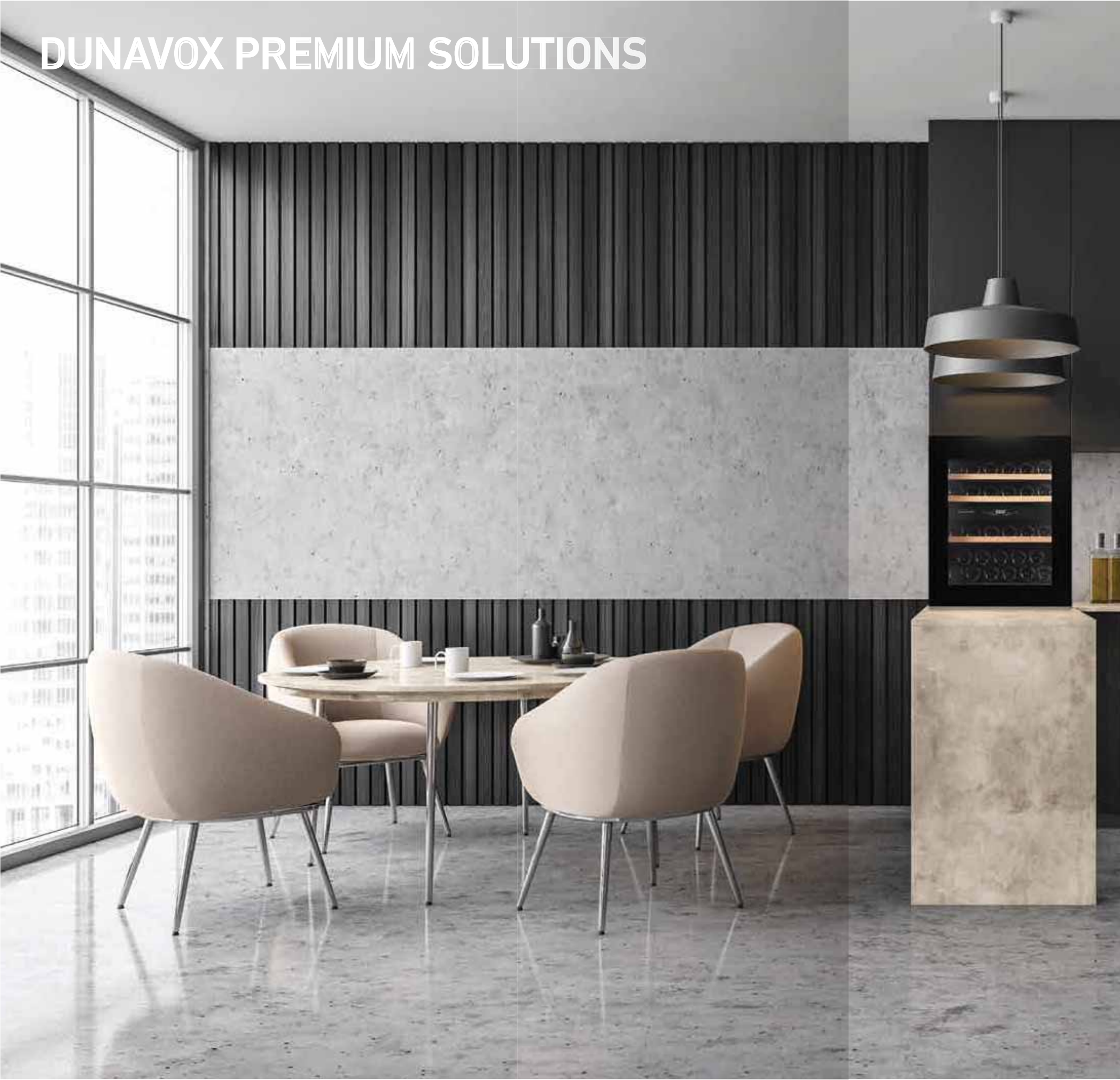

DISPLAY

The new Dunavox models feature either LED displays with touch controls or LCD displays with multicoloured internal lighting to ensure the wine cooler fits into any kitchen design.

EASY TO USE

The convenient and user-friendly touch button controls allow you to adjust the cooling zones with a simple action.



SINGLE, DUAL AND THREE TEMPERATURE ZONES

Dunavox wine coolers are available with one, two, or three cooling zones. The variety of the product range provides the possibility to store different kinds of wine at their ideal serving or storage temperature – making them versatile, quiet and reliable.

EASY TO USE

Configuring the desired temperature is easy at single, dual or even three cooling zone wine coolers.

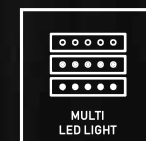

MULTI LED LIGHT

Interior LED light colour which can set to white, amber and blue. This feature gives a freedom to set the perfect lighting option for the interior.

EASY TO USE

The convenient and user-friendly touch button controls allow you to adjust the colours with a simple change.



DUNAVOX PREMIUM SOLUTIONS



PUSH-TO-OPEN

With the new trend in handleless kitchens, Dunavox have developed wine coolers that feature push-to-open technology. The doors are handle-less, a gentle push to the top of the door is enough to activate the internal sensor which opens automatically – ensuring the appliance perfectly matches with all handleless kitchens in a modern design. All of the doors close automatically if the door isn't opened within a few seconds to ensure the temperature is maintained in the cooler.

EASY TO USE

Gentle push to the top of the door is enough, and the door opened. If we do not open it further closes by itself.



INTEGRATED VENTILATION

Our newest development is self-ventilating wine coolers. This makes the wine coolers extremely easy to install as the vents usually required to create the airflow are no longer needed. There is a ventilation grille at the bottom of the cooler which allows the cool air to reach the compressor, at the top there is another ventilation grill which allows the warm air to escape. This means that integrated units can now be installed underneath worktops making them extremely easy to incorporate into modern kitchens.



OVERLAY PANEL

Overlay panel door option allows you to hide the wine cooler completely with furniture. The same furniture panel can be attached to the winecooler as the kitchen furniture has been made of. Overlay panel door option allows to hide the winecooler completely in the interior. Only available for Glance series, except Glance-18.



INVESTING IN THE WORLD



REDUCE, REUSE, RECYCLE

Reduce Reuse Recycle is known to the environmentally conscious consumers by the term of 3R's calling for an increase in the ratio of recyclable materials, reuse of raw materials and manufacturing waste and overall reduction in resources and energy used. The concept of 3R's has become the governing part in every aspect of doing business by the entire Dunavox community and has been applied to the entire lifecycles of products and services.

In order to reduce our environmental footprint, Dunavox is committed to produce and sell wine coolers of long-lasting lifetime shown by the unique 3-year warranty Dunavox wine coolers are supported by.



REDUCE

The most important way of reducing waste is by not creating waste in the first place. By reducing the usage of unwanted products, this will save our natural resources and decreases energy consumption. Dunavox's recent efforts to minimize the usage of unnecessary materials includes the use of less packaging materials, the introduction of e-manuals instead of paper-based documentation and the complete removal of any ozone harming gas from our wine coolers as well as aiming for 100% paper-free working environment at all Dunavox offices.



REUSE

We don't throw away any reusable material but try to reuse as much material as possible including cardboard packaging, protective material, pallets and other packaging substances. Broken or returned units are repaired and sold with substantial discount or donated instead of scrapping them. Unwanted office equipment is also donated to non-profitable organizations and charity.



RECYCLE

Cardboard used for packing our wine coolers contains at least 50% recycled paper and protective polyfoams are made of fully recycled polystyrene. Fans, power boards and displays are manufactured by recycled plastics. Dunavox aims for 100% recyclability in the use of all paper and polymer materials.

Dunavox ensures a separate collection of waste all along it's entire supply chain as well as in the offices.

ADVANCED TECHNOLOGY FOR REAL WINE EXPERIENCE

1 COOLING ZONE



Single temperature zone wine cooler. Ideal for cooling of a one type of wine.

2 COOLING ZONES



Dual temperature zones wine cooler. Ideal for cooling white/rosé and red wine.

3 COOLING ZONES



Three temperature zones wine cooler. Ideal for cooling all specific of wines.

TOUCH SCREEN

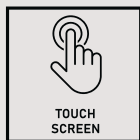

The display of the winecooler is touch screen controlled. Press the selected buttons for temperature setting or turning the light on or off.

PUSH TO OPEN



This unit is handle-less. Door opening performed by pushing the top left or right corner of the door.

HANDLE DOOR



A handle is attached to the door, this allows to open and close the door of the wine cooler.

MULTI LED LIGHT

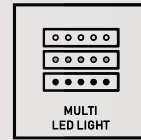

Interior LED light colour which can set to white, blue and amber.

INTERIOR LED LIGHT

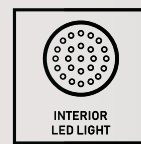

The unit has an interior LED light which can be turned on or off.

INTEGRATED

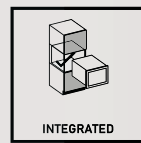

Built in/integrated units is only suitable for within kitchen cabinets. They require ventilation to the rear and there must be a grille installed in the plinth this is crucial as without it the wine coolers will not be able to cool properly.

FREE-STANDING



These coolers are not suitable for built in/integrated use and shouldn't be installed under a counter top they require free space around the sides and rear in order for the compressor to cool effectively.

UNDER-COUNTER

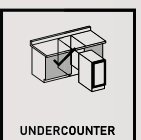

Undercounter units, as the name suggests, are designed to be installed under a counter top. Some of them are still suitable for freestanding use though.

FAN ASSISTED COOLING



Internal fans support the air circulation inside the unit. This ensures the set temperature and humidity are stable inside the wine cooler.

INTEGRATED VENTILATION



There are two ventilation grids and a special door on the unit. The grids and the door allows for enough air circulation around the unit without following the standard installation procedure which is required with integrated units – this makes installing them very easier.

UV LIGHT PROTECTION



A special layer included on the door which reduces the harmful effects of UV lights. Direct sunlight is still harmful for the unit and the wines. Please consider this when installing the winecooler.

HUMIDITY CONTROL



There is a plastic box on one of the shelves inside the unit. Filling it water allows to increase the inner humidity in the cabinet.

SINGLE ZONE TEMPERATURE

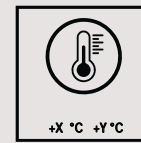

Cooling range can be set between X°C to Y°C.

DOUBLE ZONE TEMPERATURES

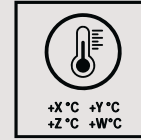

Cooling range can be set between X°C to Y°C in the upper zone, and Z°C to W°C in the lower zone.

THREE ZONE TEMPERATURES

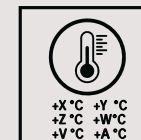

Cooling range can be set between X°C to Y°C in the upper, Z°C to W°C in the middle, and V°C to A°C in the lower zone.

BOTTLE LOADING

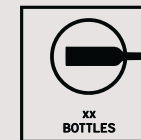

Bottle loading plan indicates how many regular bordeaux bottle fits into the wine cooler.

CHAMPAGNE & PROSECCO



This unit is dedicated for champagne & prosecco cooling.

VIBRATION FREE STORING

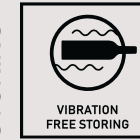

The compressor is the heart of every wine cooler. The compressor is fixed on 4 strong rubber bushes, to minimize the vibration during operation. The wine will not be affected by the regular compressor start/stop cycles.

OVERLAY PANEL

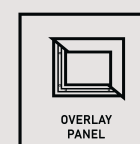

Overlay panel door option allows you to hide the wine cooler completely with furniture. The same furniture panel can be attached to the winecooler as the kitchen furniture has been made of.

WEIGHT (KGS)

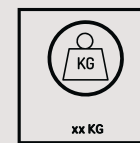

Net weight of the unit. Packaging is not included.

VOLUME (LITRES)



Total volume of the inside cabinet.

NOISE (dB)



Average noise emission of the unit.

3 YEARS WARRANTY



Dunavox provides a 3 years warranty on our products.

Dunavox Glance is our premium range, kitchen-integrated wine coolers that have been developed featuring push-to-open technology – a gentle push to the top of the door is enough to activate the internal sensor which opens automatically ensuring a perfect match with all handleless kitchens in a modern design. The integrated ventilation system allows the cool air to reach the compressor via a grille at the bottom and the warm air to escape through another grille at the top of the wine cooler. This means that the Dunavox Glance wine coolers can be installed underneath worktops and not just in tower unit, making them extremely easy to incorporate into modern kitchens.

**DUNAVOX
GLANCE**

DUNAVOX Glance-18

A single zone, 18 bottle integrated model featuring integrated ventilation. It's elegant appearance, handleless design with push2open technology is ideal for any modern kitchen. The tinted glass door can be opened by pushing the corners of the door to allow access to the bottles are displayed on solid beech wood shelves and surrounded by white, amber and blue interior LED lighting. Please note that this model is an integrated unit designed to be built in or installed undercounter, and is not intended as a freestanding wine cooler.

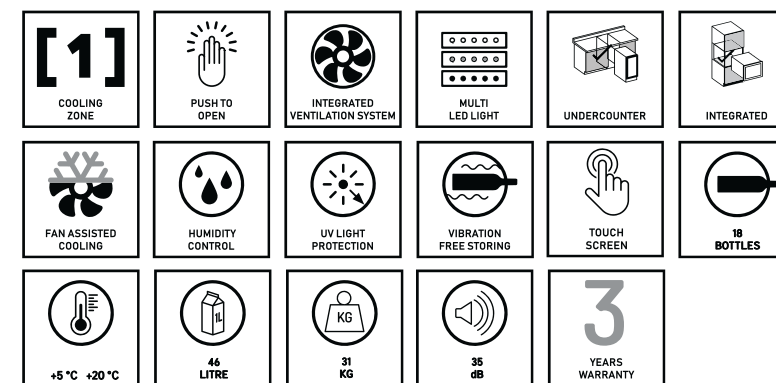

door	Reversible tinted glass door (UV treated)
shelves	Wooden shelves
lighting	White, amber and blue LED lighting
width	590 mm
height	455 mm
depth	550 mm

DAVG-18.46B.TO

DAVG-18.46SS.TO

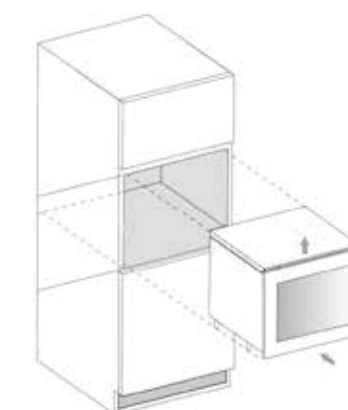

Technical support files



DUNAVOX Glance-25

A dual zone, 25 bottle integrated model featuring integrated ventilation. It's elegant appearance, handleless design with push2open technology is ideal for any modern kitchen. The tinted glass door can be opened by pushing the corners of the door to allow access to the bottles are displayed on solid beech wood shelves and surrounded by white, amber and blue interior LED lighting. Top zone must be colder than the lower zone, recommended temperature difference is 4°C. Please note that this model is an integrated unit designed to be built in or installed undercounter, and is not intended as a freestanding wine cooler.

[2] COOLING ZONES	 PUSH TO OPEN	 INTEGRATED VENTILATION SYSTEM	 MULTI LED LIGHT	 UNDERCOUNTER	 INTEGRATED
 OVERLAY PANEL	 FAN ASSISTED COOLING	 HUMIDITY CONTROL	 UV LIGHT PROTECTION	 VIBRATION FREE STORING	 TOUCH SCREEN
 25 BOTTLES	 +5 °C +20 °C +5 °C +20 °C	 43 LITRE	 42 KG	 39 dB	 3 YEARS WARRANTY

door	Reversible tinted glass door (UV treated)
shelves	Wooden shelves
lighting	White, amber and blue LED lighting
width	592 mm
height	595 mm
depth	559 mm

DAVG-25.63DB.TO DAVG-25.63DSS.TO DAVG-25.63DOP.TO

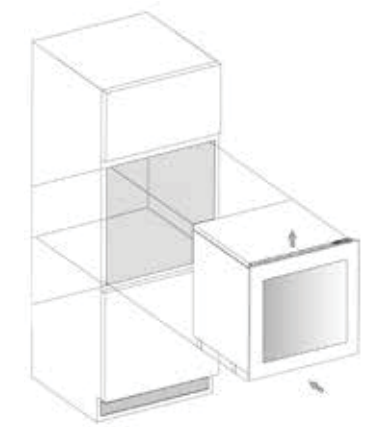

Technical support files



DUNAVOX Glance-32

A dual zone, 32 bottle integrated model featuring integrated ventilation. It's elegant appearance, handleless design with push2open technology is ideal for any modern kitchen. The tinted glass door can be opened by pushing the corners of the door to allow access to the bottles are displayed on solid beech wood shelves and surrounded by white, amber and blue interior LED lighting. Top zone must be colder than the lower zone, recommended temperature difference is 4°C. Please note that this model is an integrated unit designed to be built in or installed undercounter, and is not intended as a freestanding wine cooler.

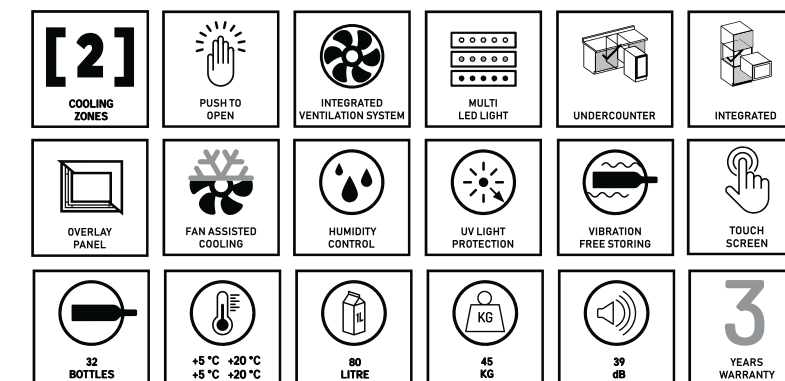

door	Reversible tinted glass door (UV treated)
shelves	Wooden shelves
lighting	White, amber and blue LED lighting
width	592 mm
height	715 mm
depth	559 mm

DAVG-32.80DB.TO DAVG-32.80DSS.TO DAVG-32.80DOP.TO

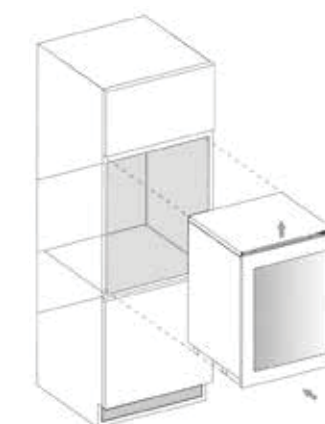

Technical support files





DUNAVOX Glance-49

A dual zone, 49 bottle integrated model featuring integrated ventilation. It's elegant appearance, handleless design with push2open technology is ideal for any modern kitchen. The tinted glass door can be opened by pushing the corners of the door to allow access to the bottles are displayed on solid beech wood shelves and surrounded by white, amber and blue interior LED lighting. Top zone must be colder than the lower zone, recommended temperature difference is 4°C. Please note that this model is an integrated unit designed to be built in or installed undercounter, and is not intended as a freestanding wine cooler.

[2] COOLING ZONES	 PUSH TO OPEN	 INTEGRATED VENTILATION SYSTEM	 MULTI LED LIGHT	 UNDERCOUNTER	 INTEGRATED
 OVERLAY PANEL	 FAN ASSISTED COOLING	 HUMIDITY CONTROL	 UV LIGHT PROTECTION	 VIBRATION FREE STORING	 TOUCH SCREEN
 49 BOTTLES	 +5°C +20°C +5°C +20°C	 116 LITRE	 55 KG	 40 dB	 3 YEARS WARRANTY

door	Reversible tinted glass door (UV treated)
shelves	Wooden shelves
lighting	White, amber and blue LED lighting
width	592 mm
height	885 mm
depth	559 mm

DAVG-49.116DB.TO DAVG-49.116DSS.TO DAVG-49.116DOP.TO

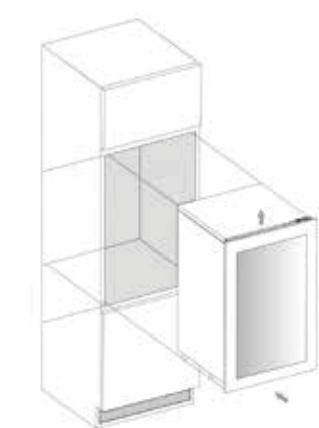

Technical support files



DUNAVOX Glance-72

A dual zone, 72 bottle integrated model featuring integrated ventilation. It's elegant appearance, handleless design with push2open technology is ideal for any modern kitchen. The tinted glass door can be opened by pushing the corners of the door to allow access to the bottles are displayed on solid beech wood shelves and surrounded by white, amber and blue interior LED lighting. Top zone must be colder than the lower zone, recommended temperature difference is 4°C. Please note that this model is designed to be built in alongside kitchen cabinets and appliances, and is not intended as a freestanding or undercounter wine cooler.

[2] COOLING ZONES	PUSH TO OPEN	INTEGRATED VENTILATION SYSTEM	MULTI LED LIGHT	INTEGRATED	OVERLAY PANEL
FAN ASSISTED COOLING	HUMIDITY CONTROL	UV LIGHT PROTECTION	VIBRATION FREE STORING	TOUCH SCREEN	72 BOTTLES
+5 °C +20 °C +5 °C +20 °C	185 LITRE	48 KG	40 dB	3 YEARS WARRANTY	

door	Reversible tinted glass door (UV treated)
shelves	Wooden shelves
lighting	White, amber and blue LED lighting
width	592 mm
height	1234 mm
depth	559 mm

DAVG-72.185DB.TO DAVG-72.185DSS.TO DAVG-72.185DOP.TO



Technical support files



DUNAVOX Glance-114

A dual zone, 114 bottle integrated model featuring integrated ventilation. It's elegant appearance, handleless design with push2open technology is ideal for any modern kitchen. The tinted glass door can be opened by pushing the corners of the door to allow access to the bottles are displayed on solid beech wood shelves and surrounded by white, amber and blue interior LED lighting. Top zone must be colder than the lower zone, recommended temperature difference is 4°C. Please note that this model is designed to be built in alongside kitchen cabinets and appliances, and is not intended as a freestanding or undercounter wine cooler.

[2] COOLING ZONES	PUSH TO OPEN	INTEGRATED VENTILATION SYSTEM	MULTI LED LIGHT	INTEGRATED	OVERLAY PANEL
FAN ASSISTED COOLING	HUMIDITY CONTROL	UV LIGHT PROTECTION	VIBRATION FREE STORING	TOUCH SCREEN	114 BOTTLES
+5 °C +20 °C +5 °C +20 °C	288 LITRE	88 KG	40 dB	3 YEARS WARRANTY	

door	Reversible tinted glass door (UV treated)
shelves	Wooden shelves
lighting	White, amber and blue LED lighting
width	592 mm
height	1784 mm
depth	559 mm

DAVG-114.288DB.TO DAVG-114.288DSS.TO DAVG-114.288DOP.TO

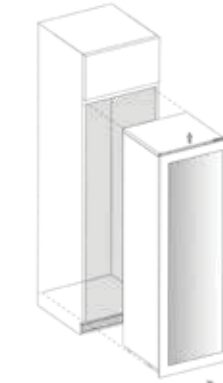
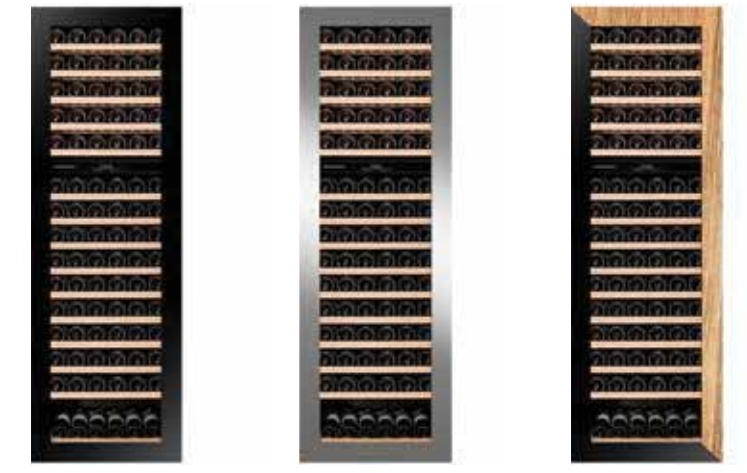

Technical support files



Dunavox Soul, are kitchen-integrated wine coolers boast an elegant exterior with stainless steel or black handles. The integrated ventilation system allows the cool air to reach the compressor via a grille at the bottom and the warm air to escape through another grille at the top of the wine cooler. This means that Dunavox Soul wine coolers can be installed underneath worktops as well as in column installations, making them extremely easy to incorporate into modern kitchens



DUNAVOX
SOUL

DUNAVOX Soul-18

A single zone, 18 bottle integrated model featuring integrated ventilation. Boasting an elegant exterior and a stainless steel door handle, the DUNAVOX Soul-18 is perfect for contemporary kitchen environments. The bottles are displayed on solid beech wood shelves and surrounded by white, amber and blue interior LED lighting. Please note that this model is an integrated unit designed to be built in or installed undercounter, and is not intended as a freestanding wine cooler.

[1] COOLING ZONE	HANDLE DOOR	INTEGRATED VENTILATION SYSTEM	MULTI LED LIGHT	UNDERCOUNTER	INTEGRATED
FAN ASSISTED COOLING	HUMIDITY CONTROL	UV LIGHT PROTECTION	VIBRATION FREE STORING	TOUCH SCREEN	18 BOTTLES
+5 °C +20 °C	46 LITRE	30 KG	35 dB	3 YEARS WARRANTY	

door	Reversible tinted glass door (UV treated)
shelves	Wooden shelves
lighting	White, amber and blue LED lighting
width	590 mm
height	455 mm
depth	550 mm

DAVS-18.46B

DAVS-18.46SS

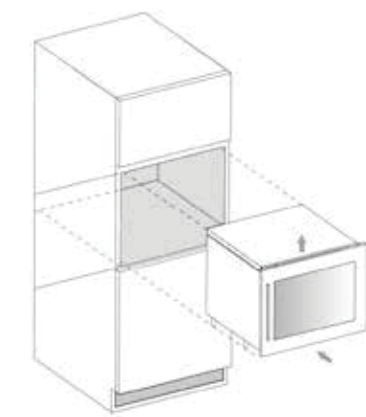

Technical support files



DUNAVOX Soul-25

A dual zone, 25 bottle integrated model featuring integrated ventilation. Boasting an elegant exterior and a stainless steel door handle, the DUNAVOX Soul-25 is perfect for contemporary kitchen environments. The bottles are displayed on solid beech wood shelves and surrounded by white, amber and blue interior LED lighting. Top zone must be colder than the lower zone, recommended temperature difference is 4°C. Please note that this model is an integrated unit designed to be built in or installed undercounter, and is not intended as a freestanding wine cooler.

[2] COOLING ZONES	HANDLE DOOR	INTEGRATED VENTILATION SYSTEM	MULTI LED LIGHT	UNDERCOUNTER	INTEGRATED
FAN ASSISTED COOLING	HUMIDITY CONTROL	UV LIGHT PROTECTION	VIBRATION FREE STORING	TOUCH SCREEN	25 BOTTLES
+5°C +20°C +5°C +20°C	63 LITRE	37 KG	39 dB	3 YEARS WARRANTY	

door	Reversible tinted glass door (UV treated)
shelves	Wooden shelves
lighting	White, amber and blue LED lighting
width	590 mm
height	595 mm
depth	570 mm

DAVS-25.63DB

DAVS-25.63DSS

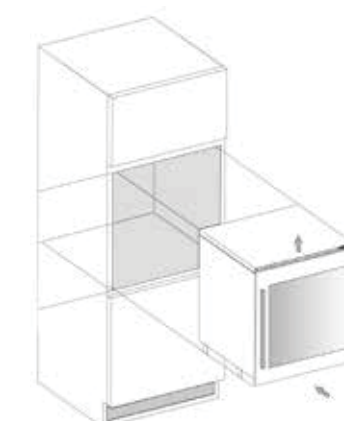

Technical support files



DUNAVOX Soul-41

A dual zone, 41 bottle integrated wine cooler. Boasting an elegant exterior and a stainless steel door handle, the DUNAVOX Soul-41 is perfect for contemporary kitchen environments. The bottles are displayed on solid beech wood shelves and surrounded by white, amber and blue interior LED lighting. Please note that this model is designed to be built alongside kitchen cabinets and appliances, and is not intended as a freestanding or undercounter wine cooler. This unit requires ventilation to the rear and there must be a grille installed in the plinth this is crucial as without it the wine coolers will not be able to cool properly.

[2] COOLING ZONES	HANDLE DOOR	MULTI LED LIGHT	INTEGRATED	FAN ASSISTED COOLING	HUMIDITY CONTROL
UV LIGHT PROTECTION	VIBRATION FREE STORING	TOUCH SCREEN	41 BOTTLES	+5 °C +10 °C +10 °C +18 °C	83 LITRE
39 KG	43 dB	3 YEARS WARRANTY			

door	Reversible tinted glass door (UV treated)
shelves	Wooden shelves
lighting	White, amber and blue LED lighting
width	590 mm
height	590 mm
depth	556 mm

DAB-41.83DB



DAB-41.83DSS

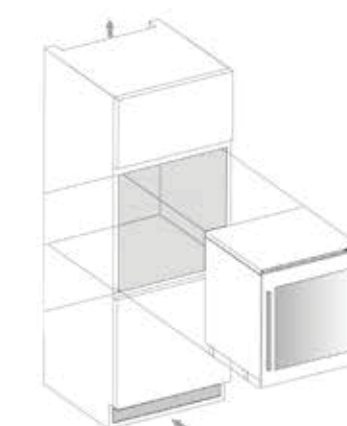

Technical support files



DUNAVOX Soul-42

A dual zone, 42 bottle integrated wine cooler. Boasting an elegant exterior and a stainless steel door handle, the DUNAVOX Soul-42 is perfect for contemporary kitchen environments. The bottles are displayed on solid beech wood shelves and surrounded by white, amber and blue interior LED lighting. The top zone must be colder than the lower zone. Please note that this model is designed to be built in alongside kitchen cabinets and appliances, and is not intended as a freestanding or undercounter wine cooler. This unit requires ventilation to the rear and there must be a grille installed in the plinth this is crucial as without it the wine coolers will not be able to cool properly.

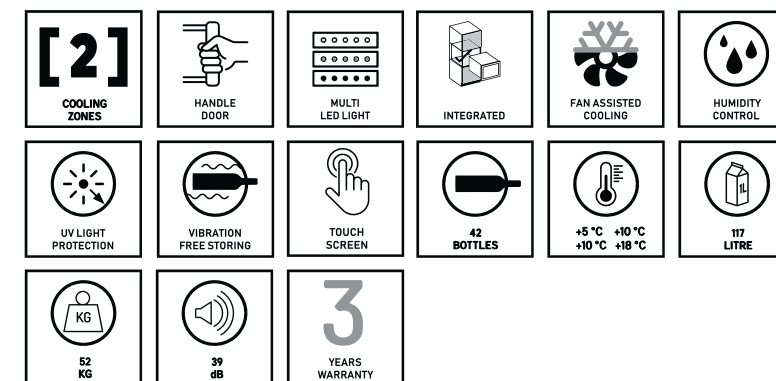

door	Reversible tinted glass door (UV treated)
shelves	Wooden shelves
lighting	White, amber and blue LED lighting
width	590 mm
height	885 mm
depth	560 mm

DAB-42.117DB

DAB-42.117DSS

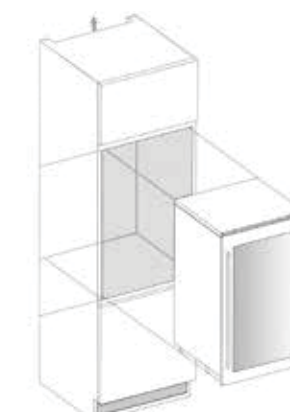

Technical support files





DUNAVOX Soul-49

A dual zone, 49 bottle integrated model featuring integrated ventilation. Boasting an elegant exterior and a stainless steel door handle, the DUNAVOX Soul-49 is perfect for contemporary kitchen environments. The bottles are displayed on solid beech wood shelves and surrounded by white, amber and blue interior LED lighting. Top zone must be colder than the lower zone, recommended temperature difference is 4°C. Please note that this model is an integrated unit designed to be built in or installed undercounter, and is not intended as a freestanding wine cooler.

[2] COOLING ZONES	HANDLE DOOR	INTEGRATED VENTILATION SYSTEM	MULTI LED LIGHT	UNDERCOUNTER	INTEGRATED
FAN ASSISTED COOLING	HUMIDITY CONTROL	UV LIGHT PROTECTION	VIBRATION FREE STORING	TOUCH SCREEN	49 BOTTLES
+5°C +20°C +5°C +20°C	116 LITRE	48 KG	40 dB	3 YEARS WARRANTY	

door	Reversible tinted glass door (UV treated)
shelves	Wooden shelves
lighting	White, amber and blue LED lighting
width	590 mm
height	885 mm
depth	550 mm

DAVS-49.116DB



DAVS-49.116DSS

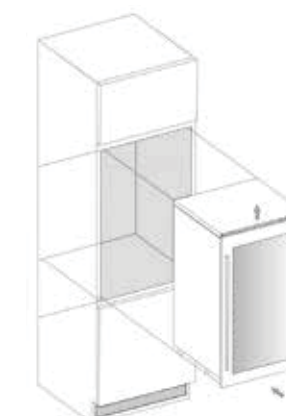

Technical support files



DUNAVOX Soul-72

A dual zone, 72 bottle integrated model featuring integrated ventilation. Boasting an elegant exterior and a stainless steel door handle, the DUNAVOX Soul-72 is perfect for contemporary kitchen environments. The bottles are displayed on solid beech wood shelves and surrounded by white, amber and blue interior LED lighting. Top zone must be colder than the lower zone, recommended temperature difference is 4°C. Please note that this model is designed to be built in alongside kitchen cabinets and appliances, and is not intended as a freestanding or undercounter wine cooler.

[2] COOLING ZONES	HANDLE DOOR	INTEGRATED VENTILATION SYSTEM	MULTI LED LIGHT	INTEGRATED	FAN ASSISTED COOLING
HUMIDITY CONTROL	UV LIGHT PROTECTION	VIBRATION FREE STORING	TOUCH SCREEN	72 BOTTLES	+5 °C +20 °C +5 °C +20 °C
185 LITRE	67 KG	40 dB	3 YEARS WARRANTY		

door	Reversible tinted glass door (UV treated)
shelves	Wooden shelves
lighting	White, amber and blue LED lighting
width	590 mm
height	1234 mm
depth	570 mm

DAVS-72.185DB

DAVS-72.185DSS

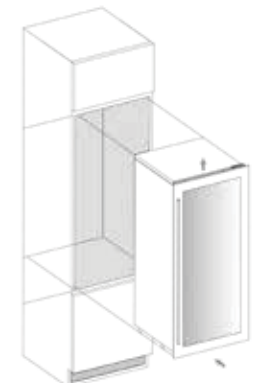

Technical support files



DUNAVOX Soul-89

A three zone, 89 bottle integrated wine cooler. Boasting an elegant exterior and a stainless steel door handle, the DUNAVOX Soul-89 is perfect for contemporary kitchen environments. The bottles are supported on solid wooden shelves set into a white interior. The top zone must be colder than the lower zone. Please note that this model is designed to be built alongside kitchen cabinets and appliances, and is not intended as a freestanding or undercounter wine cooler. This unit requires ventilation to the rear and there must be a grille installed in the plinth this is crucial as without it the wine coolers will not be able to cool properly.

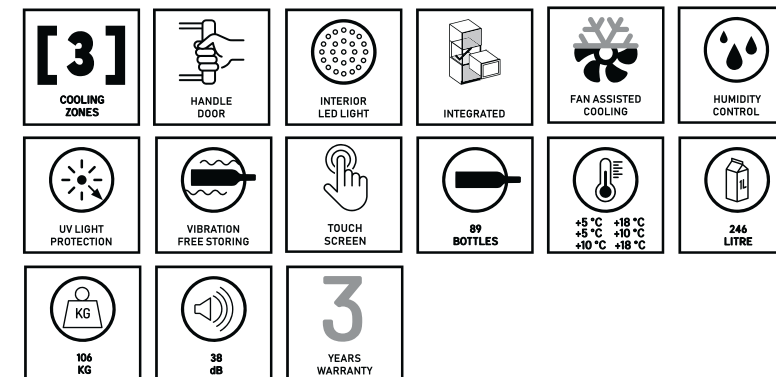

door	Reversible tinted glass door (UV treated)
shelves	Wooden shelves
lighting	White interior LED lighting
width	587 mm
height	1788 mm
depth	557 mm

DX-89.246TB



DX-89.246TSS

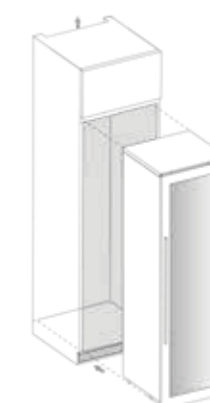

Technical support files



Dunavox Flow undercounter wine coolers feature a removable ventilation grille at the bottom and are manufactured in widths to match normal kitchen cabinets. The standard height is 820 mm to match the standard door height of a kitchen but the range also includes handleless models in line with the German handleless kitchen countertop heights of 885-890 mm to create seamless finish.



**DUNAVOX
FLOW**

DUNAVOX Flow-9

A single zone, 9 bottle undercounter model. It's elegant appearance and stainless steel door handle make it especially representative in modern kitchens with limited space. The bottles are supported on fixed shelves set into a stunning light white interior. Please note that this model is intended as a built in undercounter unit.

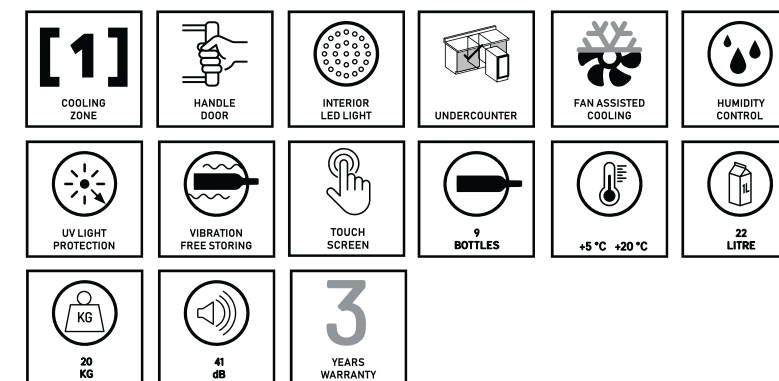

door	Reversible tinted glass door (UV treated)
shelves	Wooden shelves
lighting	White interior LED lighting
width	150 mm
height	820 mm
depth	525 mm

DAUF-9.22B

DAUF-9.22SS

DAUF-9.22W

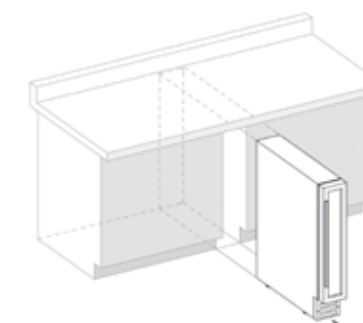

Technical support files



DUNAVOX Flow-17

A dual temperature zone, 17 bottle undercounter model, boasting an elegant exterior and a stainless steel door handle. The DUNAVOX Flow-17 is perfect for contemporary kitchen environments. Bottles are supported on solid wooden shelves set into a stunning light blue interior. Please note that this model is intended as a built in undercounter unit.

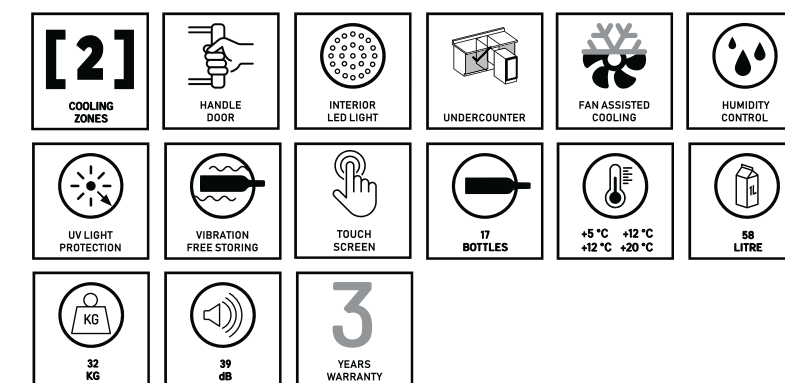

door	Reversible tinted glass door (UV treated)
shelves	Wooden shelves
lighting	Blue interior LED lighting
width	295 mm
height	813 mm
depth	570 mm

DAUF-17.58DB

DAUF-17.58DSS

DAUF-17.58DW

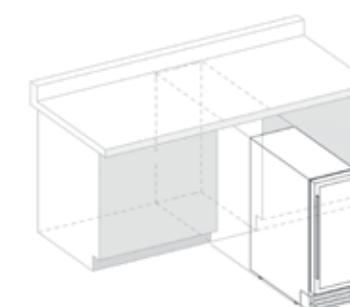

Technical support files



DUNAVOX Flow-19

A single temperature zone, 19 bottle undercounter model, boasting an elegant exterior and a stainless steel door handle. The DUNAVOX Flow-19 is perfect for contemporary kitchen environments. Bottles are supported on solid wooden shelves set into a stunning light blue interior. Please note that this model is intended as a built in undercounter unit.

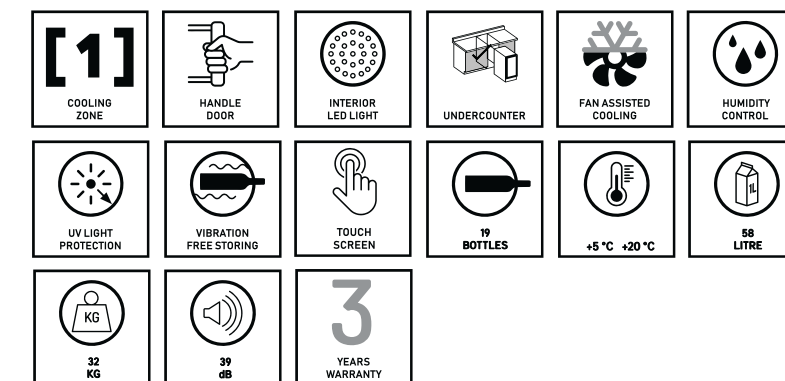

door	Reversible tinted glass door (UV treated)
shelves	Wooden shelves
lighting	Blue interior LED lighting
width	295 mm
height	813 mm
depth	570 mm

DAUF-19.58B

DAUF-19.58SS

DAUF-19.58W



Technical support files

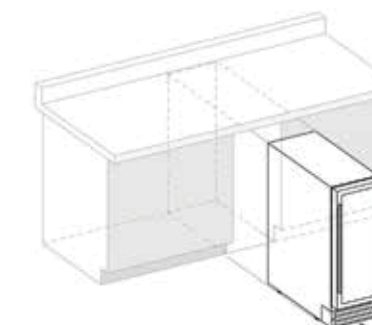

DUNAVOX Flow-32

A single temperature zone, 32 bottle undercounter model, boasting an elegant exterior and a stainless steel door handle. The DUNAVOX Flow-32 is perfect for contemporary kitchen environments. Bottles are supported on solid wooden shelves and surrounded by white, amber and blue interior LED lighting. Please note that this model is intended as a built in undercounter unit.

[1] COOLING ZONE	HANDLE DOOR	MULTI LED LIGHT	UNDERCOUNTER	FREESTANDING	FAN ASSISTED COOLING
HUMIDITY CONTROL	UV LIGHT PROTECTION	VIBRATION FREE STORING	TOUCH SCREEN	32 BOTTLES	+5°C +18°C
83 LITRE	31 KG	39 dB	3 YEARS WARRANTY		

door	Reversible tinted glass door (UV treated)
shelves	Wooden shelves
lighting	White, amber and blue LED lighting
width	380 mm
height	820 mm
depth	563 mm

DAUF-32.83B

DAUF-32.83SS



Technical support files



DUNAVOX Flow-32D

A dual temperature zone, 32 bottle undercounter model, boasting an elegant exterior and a stainless steel door handle. The DUNAVOX Flow-32D is perfect for contemporary kitchen environments. Bottles are supported on solid wooden shelves and surrounded by white, amber and blue interior LED lighting. The lower zone must be colder than the upper zone. Please note that this model is intended as a built in undercounter unit.

[2] COOLING ZONES	HANDLE DOOR	MULTI LED LIGHT	UNDERCOUNTER	FREESTANDING	FAN ASSISTED COOLING
HUMIDITY CONTROL	UV LIGHT PROTECTION	VIBRATION FREE STORING	TOUCH SCREEN	32 BOTTLES	+10 °C +18 °C +5 °C +10 °C
78 LITRE	31 KG	39 dB	3 YEARS WARRANTY		

door	Reversible tinted glass door (UV treated)
shelves	Wooden shelves
lighting	White, amber and blue LED lighting
width	380 mm
height	820 mm
depth	563 mm

DAUF-32.78DB



DAUF-32.78DSS

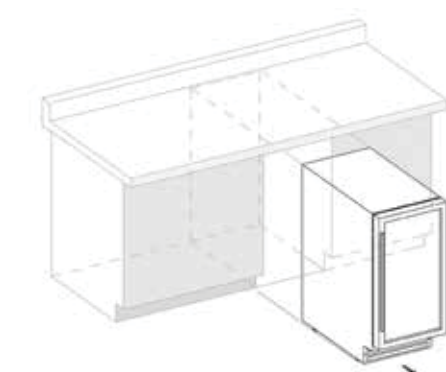

Technical support files



DUNAVOX Flow-38

A dual zone, 38 bottle integrated model. Boasting an elegant exterior and a stainless steel door handle, the DUNAVOX Flow-38 is perfect for contemporary kitchen environments. The bottles are displayed on solid beech wood shelves and surrounded by white, amber and blue interior LED lighting. Top zone must be colder than the lower zone, recommended temperature difference is 4°C. Please note that this model is suitable for freestanding or built in use.

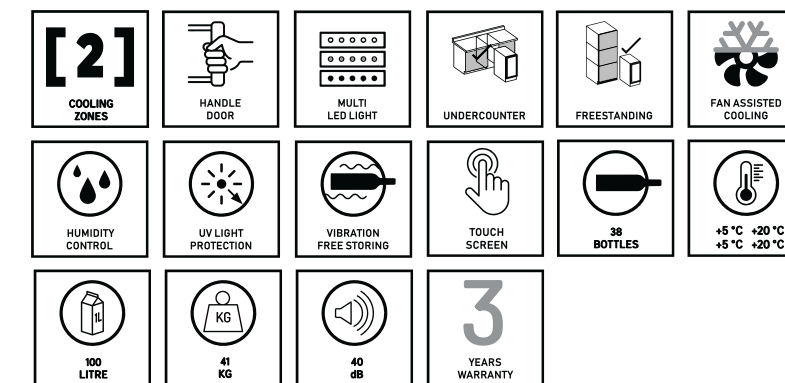

door	Reversible tinted glass door (UV treated)
shelves	Wooden shelves
lighting	White, amber and blue LED lighting
width	495 mm
height	820 mm
depth	575 mm

DAUF-38.100DB

DAUF-38.100DSS

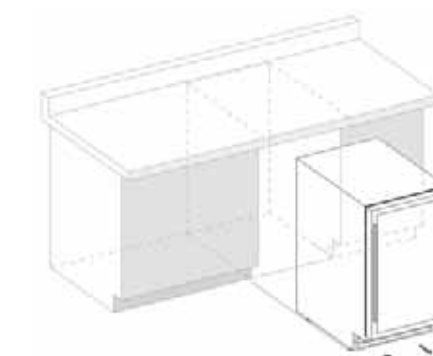

Technical support files



DUNAVOX Flow-38.TO

A dual zone, 38 bottle integrated model. It's elegant appearance, handleless design with push2open technology is ideal for any modern kitchen. The tinted glass door can be opened by pushing the corners of the door to allow access to the bottles are displayed on solid beech wood shelves and surrounded by white, amber and blue interior LED lighting. Top zone must be colder than the lower zone, recommended temperature difference is 4°C. Please note that this model is suitable for freestanding or built in use.

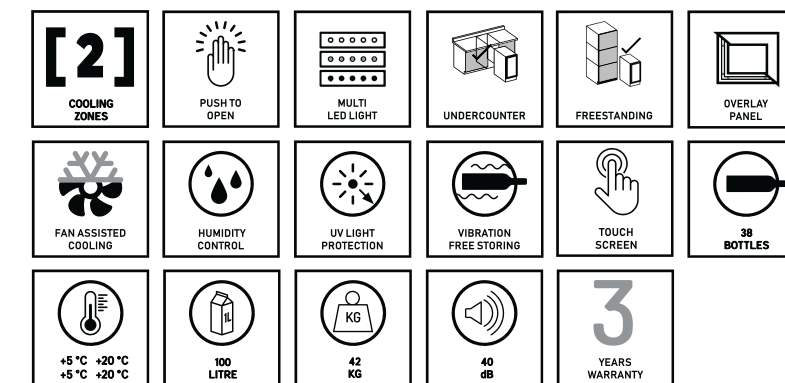

door	Reversible tinted glass door (UV treated)
shelves	Wooden shelves
lighting	White, amber and blue LED lighting
width	495 mm
height	880 mm
depth	575 mm

DAUF-38.100DB.TO DAUF-38.100DSS.TO DAUF-38.100DOP.TO

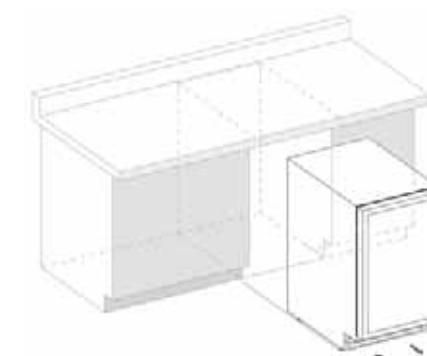

Technical support files



DUNAVOX Flow-39

A dual zone, 39 bottle undercounter model. It's a redesigned version of one of the most popular undercounter model. Boasting an elegant exterior and a stainless steel door handle. The DUNAVOX Flow-39 is perfect for contemporary kitchen environments. Bottles are supported on solid wooden shelves and surrounded by white, amber and blue interior LED lighting. The top zone must be colder than the lower zone. Please note that this model is intended as a built in undercounter unit.

[2] COOLING ZONES	HANDLE DOOR	MULTI LED LIGHT	UNDERCOUNTER	FREESTANDING	FAN ASSISTED COOLING
HUMIDITY CONTROL	UV LIGHT PROTECTION	VIBRATION FREE STORING	TOUCH SCREEN	39 BOTTLES	+5 °C +12 °C +12 °C +18 °C
121 LITRE	40 KG	38 dB	3 YEARS WARRANTY		

door	Reversible tinted glass door (UV treated)
shelves	Wooden shelves
lighting	White, amber and blue LED lighting
width	595 mm
height	820 mm
depth	560 mm

DAUF-39.121DB

DAUF-39.121DSS

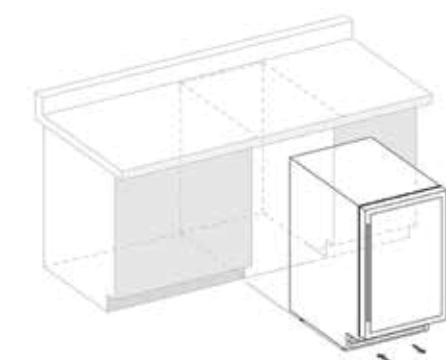

Technical support files



DUNAVOX Flow-40

A single zone, 40 bottle undercounter model. Boasting an elegant exterior and a stainless steel door handle. The DUNAVOX Flow-40 is perfect for contemporary kitchen environments. Bottles are supported on patent display shelves set into a stunning light white, amber and blue interior. Please note that this model is intended as a built-in undercounter model. Cannot be used as a freestanding model.

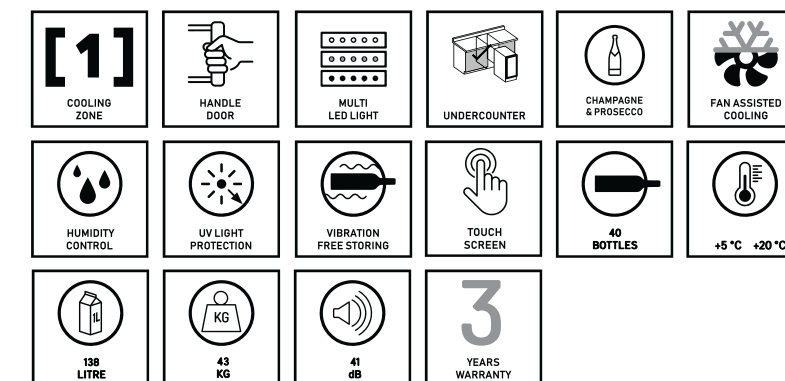

door	Reversible tinted glass door (UV treated)
shelves	Telescopic display shelves
lighting	White, amber and blue LED lighting
width	595 mm
height	813 mm
depth	570 mm

DAUF-40.138B

DAUF-40.138SS

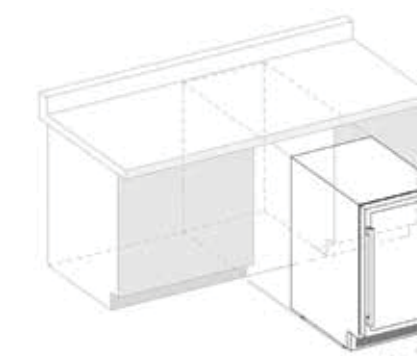

Technical support files



DUNAVOX Flow-45

A dual zone, 45 bottle undercounter model. It's elegant appearance, handleless design with push2open technology is ideal for any modern kitchen. The tinted glass door can be opened by pushing the corners of the door to allow access to the bottles are displayed on solid beech wood shelves and surrounded by white, amber and blue interior LED lighting. Top zone must be colder than the lower zone, recommended temperature difference is 4°C. Please note that this model is intended as a built in undercounter unit.

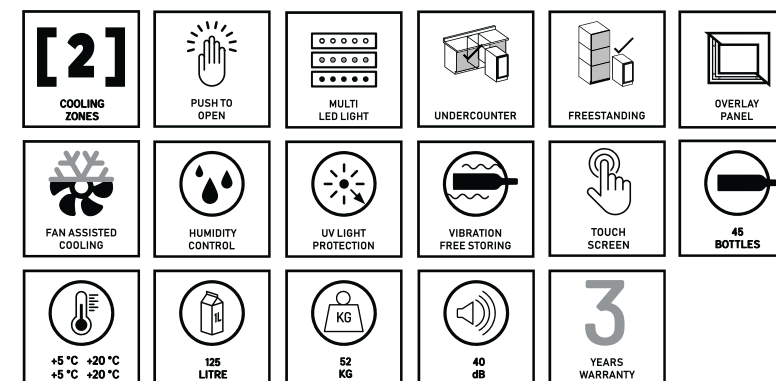

door	Reversible tinted glass door (UV treated)
shelves	Wooden shelves
lighting	White, amber and blue LED lighting
width	595 mm
height	880 mm
depth	577 mm

DAUF-45.125DB.TO DAUF-45.125DSS.TO DAUF-45.125DOP.TO

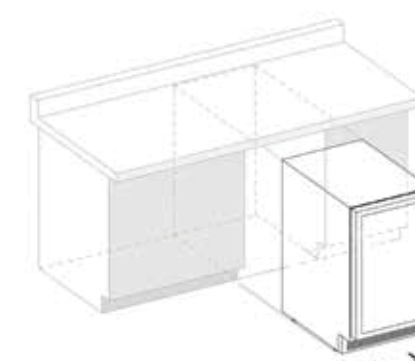

Technical support files



DUNAVOX Flow-46

A single zone, 46 bottle undercounter model. It's a redesigned version of one of the most popular undercounter model. Boasting an elegant exterior and a stainless steel door handle. The DUNAVOX Flow-46 is perfect for contemporary kitchen environments. Bottles are supported on solid wooden shelves and surrounded by white, amber and blue interior LED lighting. Please note that this model is intended as a built-in undercounter unit.

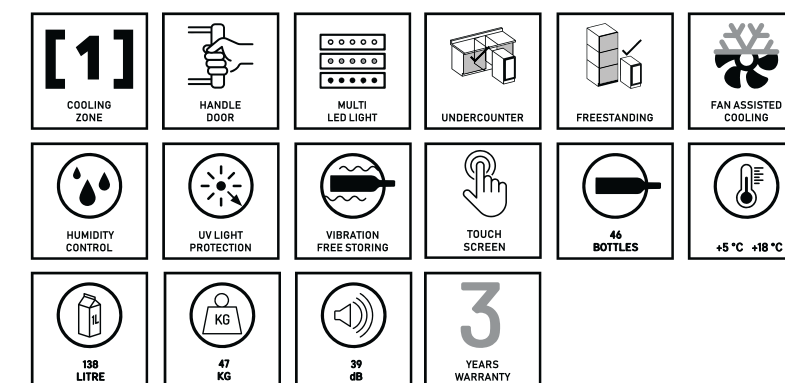

door	Reversible tinted glass door (UV treated)
shelves	Wooden shelves
lighting	White, amber and blue LED lighting
width	595 mm
height	820 mm
depth	560 mm

DAUF-46.138B

DAUF-46.138SS

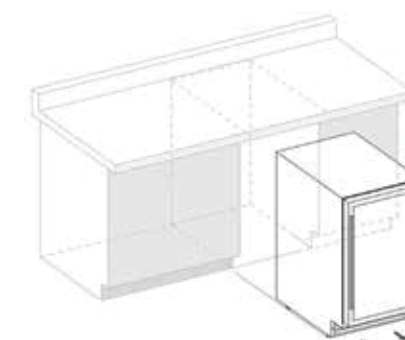

Technical support files



DUNAVOX Flow-46D

A dual zone, 46 bottle undercounter model. Boasting an elegant exterior and LCD display. The DUNAVOX Flow-46D is perfect for contemporary kitchen environments. Bottles are supported on telescopic rails and surrounded by white, amber and blue interior LED lighting. The top zone must be colder than the lower zone. Please note that this model is intended as a built in undercounter unit.

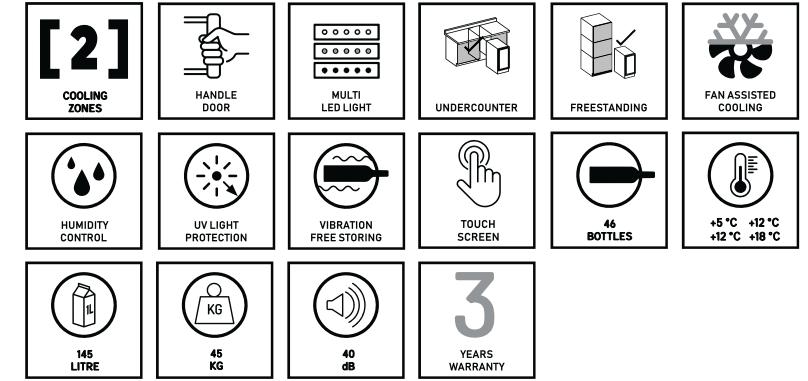

door	Reversible tinted glass door (UV treated)
shelves	Wooden shelves - telescopic
lighting	White, amber and blue LED lighting
width	595 mm
height	820 mm
depth	578 mm

DAUF-46.145DB

DAUF-46.145DSS

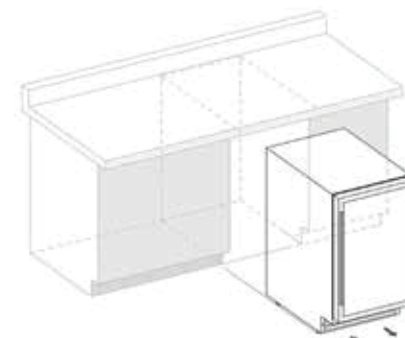

Technical support files



Dunavox Home freestanding wine coolers feature a recessed handle door. The name Home suggests that these wine coolers can be placed anywhere at your home – even in your dining or living room. They are not suitable to be built in or under counter but can be a perfect styling element to your alfresco area.

DUNAVOX
HOME

DUNAVOX Home-16

A single zone, 15 bottle model. The smallest freestanding model with a recessed handle. Bottles are supported on solid wooden shelves. This cooler supports the storage of opened bottles. This unit isn't suitable to be built in or under a counter.

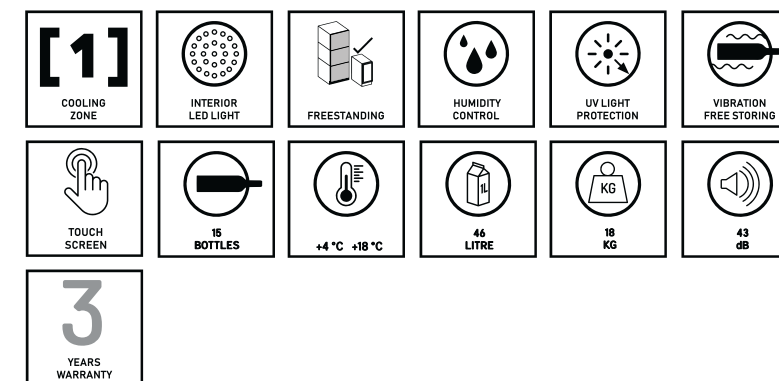

door	Non-reversible glass door (UV treated)
shelves	Wooden shelves
lighting	Blue interior LED lighting
width	430 mm
height	510 mm
depth	480 mm

DXFH-16.46



Technical support files



DUNAVOX Home-20

A single zone, 20 bottle model. The cooler has a recessed door handle and the bottles are supported on solid wooden shelves. This cooler supports the storage of open bottles. This unit isn't suitable to be built in or under a counter.

[1] COOLING ZONE	INTERIOR LED LIGHT	FREESTANDING	HUMIDITY CONTROL	UV LIGHT PROTECTION	VIBRATION FREE STORING
TOUCH SCREEN	20 BOTTLES	+4 °C +18 °C	62 LITRE	22 KG	44 dB
3 YEARS WARRANTY					

door	Non-reversible glass door (UV treated)
shelves	Wooden shelves
lighting	Blue interior LED lighting
width	430 mm
height	650 mm
depth	480 mm

DXFH-20.62



Technical support files



DUNAVOX Home-28

A single zone, 28 bottle model. The cooler has a recessed door handle. Bottles are supported on solid wooden shelves. This cooler supports the storage of open bottles. This unit isn't suitable to be built in or under a counter.

[1] COOLING ZONE	 INTERIOR LED LIGHT	 FREESTANDING	 HUMIDITY CONTROL	 UV LIGHT PROTECTION	 VIBRATION FREE STORING
 TOUCH SCREEN	 28 BOTTLES	 +4 °C +18 °C	 88 LITRE	 26 KG	 44 dB
3 YEARS WARRANTY					

door	Non-reversible glass door (UV treated)
shelves	Wooden shelves
lighting	Blue interior LED lighting
width	430 mm
height	830 mm
depth	480 mm

DXFH-28.88



Technical support files



DUNAVOX Home-30

A dual zone, 29 bottle model. The cooler has a recessed door handle and the bottles are supported on solid wooden shelves. This cooler supports the storage of open bottles. The top zone must be colder than the lower zone, temperature difference between the zones cannot be exceed 6°C. This unit isn't suitable to be built in or under a counter.

[2] COOLING ZONES	INTERIOR LED LIGHT	FREESTANDING	FAN ASSISTED COOLING	HUMIDITY CONTROL	UV LIGHT PROTECTION
VIBRATION FREE STORING	TOUCH SCREEN	29 BOTTLES	+5 °C +18 °C +5 °C +18 °C	80 LITRE	28 KG
40 dB	3 YEARS WARRANTY				

door	Non-reversible glass door (UV treated)
shelves	Wooden shelves
lighting	Blue interior LED lighting
width	480 mm
height	840 mm
depth	490 mm

DXFH-30.80



Technical support files

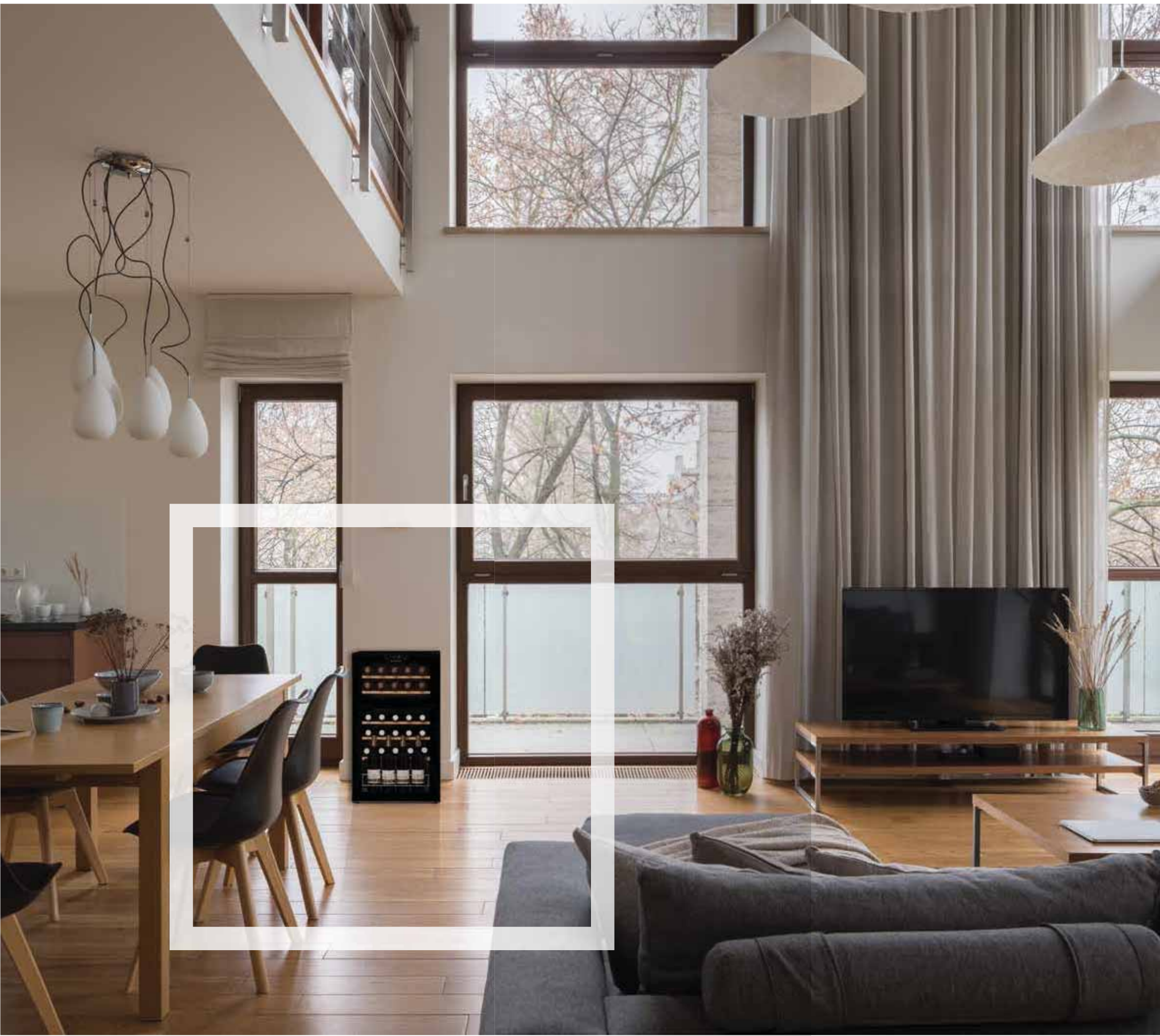

DUNAVOX Home-48

A single zone, 48 bottle model. The cooler has a recessed door handle and the bottles are supported on solid wooden shelves. This cooler supports the storage of opened bottles. This unit isn't suitable to be built in or under a counter. This model has a mechanical thermostat making it very reliable.

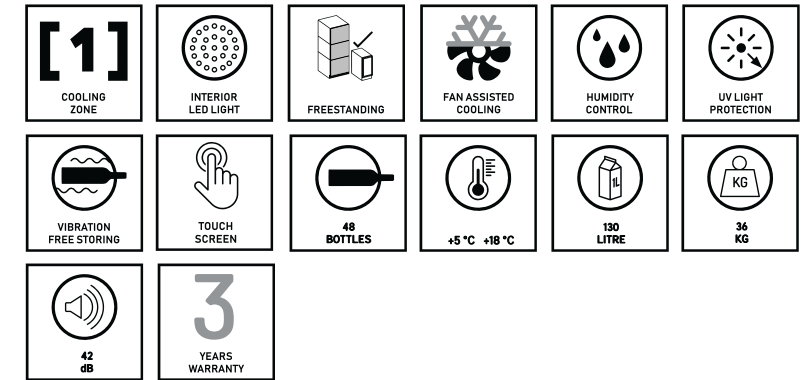

door	Non-reversible glass door (UV treated)
shelves	Wooden shelves
lighting	Blue interior LED lighting
width	540 mm
height	835 mm
depth	540 mm

DXFH-48.130



Technical support files



DUNAVOX Home-54

A dual zone 54 bottle model. The cooler has a recessed door handle and the bottles are supported on solid wooden shelves. This cooler supports the storage of opened bottles. The top zone must be colder than the lower zone, temperature difference between the zones cannot be exceed 6°C. This unit isn't suitable to be built in or under a counter.

[2] COOLING ZONES	 INTERIOR LED LIGHT	 FREESTANDING	 FAN ASSISTED COOLING	 HUMIDITY CONTROL	 UV LIGHT PROTECTION
 VIBRATION FREE STORING	 TOUCH SCREEN	 54 BOTTLES	 +5 °C +18 °C +5 °C +18 °C	 150 LITRE	 48 KG
 39 dB	3 YEARS WARRANTY				

door	Non-reversible glass door (UV treated)
shelves	Wooden shelves
lighting	Blue interior LED lighting
width	480 mm
height	1295 mm
depth	510 mm

DXFH-54.150

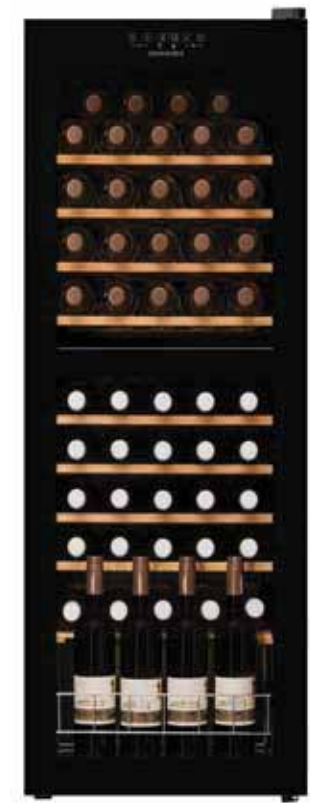

Technical support files



Dunavox Grande premium wine cooler range is ideal for the professional storage of larger wine collections and also suitable for commercial environments. Some of the Dunavox Grande models are suitable for built-in use since they are front venting, allowing for the correct air flow to cool the high capacity compressor.



DUNAVOX GRANDE

DUNAVOX Grande-58

A dual zone, 58 bottles freestanding model from Dunavox's Grande range. Boasting an elegant exterior and a stainless steel door handle, the DUNAVOX Grande-58 is perfect for contemporary kitchen environments, restaurants or hotels. The bottles are supported on patent display shelves and surrounded by white, amber and blue two-side LED lighting. The top zone must be colder than the lower zone. Please note that this model is suitable for freestanding or built in use.

[2] COOLING ZONES	HANDLE DOOR	MULTI LED LIGHT	FREESTANDING	INTEGRATED	FAN ASSISTED COOLING
HUMIDITY CONTROL	UV LIGHT PROTECTION	VIBRATION FREE STORING	TOUCH SCREEN	58 BOTTLES	CHAMPAGNE & PROSECCO
+5 °C +12 °C +12 °C +20 °C	258 LITRE	72 KG	38 dB	3 YEARS WARRANTY	

door	Reversible tinted glass door (UV treated)
shelves	Telescopic display shelves
lighting	White, amber and blue two-side LED lighting
width	595 mm
height	1215 mm
depth	680 mm

DX-58.258DB

DX-58.258DSS



Technical support files



DUNAVOX Grande-70

A single zone, 70 bottles freestanding model from Dunavox's Grande range. Boasting an elegant exterior and a stainless steel door handle, the DUNAVOX Grande-70 is perfect for contemporary kitchen environments, restaurants or hotels. The bottles are supported on patent display shelves and surrounded by white, amber and blue two-side LED lighting. Please note that this model is suitable for freestanding or built in use.

[1] COOLING ZONE	HANDLE DOOR	MULTI LED LIGHT	FREESTANDING	INTEGRATED	FAN ASSISTED COOLING
HUMIDITY CONTROL	UV LIGHT PROTECTION	VIBRATION FREE STORING	TOUCH SCREEN	70 BOTTLES	CHAMPAGNE & PROSECCO
+5°C +20°C	258 LITRE	72 KG	38 dB	3 YEARS WARRANTY	

door	Reversible tinted glass door (UV treated)
shelves	Telescopic display shelves
lighting	White, amber and blue two-side LED lighting
width	595 mm
height	1200 mm
depth	680 mm

DX-70.258B

DX-70.258SS



Technical support files



DUNAVOX Grande-94

A dual zone, 94 bottle freestanding model from Dunavox's Grande range. Boasting an elegant exterior - the SDSL model has a stainless steel handle and the black unit has a recessed handle. The DUNAVOX Grande-94 is perfect for contemporary kitchen environments and the bottles are supported on solid wooden shelves set into a stunning light blue interior. The top zone must be colder than the lower zone. Please note that this model is suitable for freestanding or built in use.

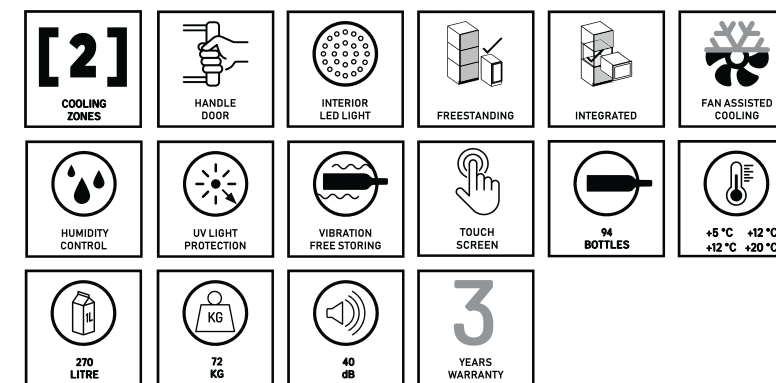

door	Reversible tinted glass door (UV treated)
shelves	Wooden shelves
lighting	Blue interior LED lighting
width	595 mm
height	1215 mm
depth	680 mm

DX-94.270DBK

DX-94.270SDSK



Technical support files



DUNAVOX Grande-123

A dual zone, 123 bottle freestanding model from Dunavox's Grande range. Boasting an elegant exterior - the DUNAVOX Grande-123 is perfect for contemporary kitchens, bars and hotels. The bottles are displayed on solid beech wood shelves and surrounded by white, amber and blue interior LED lighting. The top zone must be colder than the lower zone, recommended temperature difference is 4°C. Please note that this model is suitable for freestanding or built in use.

[2] COOLING ZONES	HANDLE DOOR	MULTI LED LIGHT	FREESTANDING	INTEGRATED	FAN ASSISTED COOLING
HUMIDITY CONTROL	UV LIGHT PROTECTION	VIBRATION FREE STORING	TOUCH SCREEN	123 BOTTLES	+5 °C +20 °C +5 °C +20 °C
338 LITRE	83 KG	41 dB	3 YEARS WARRANTY		

door	Reversible tinted glass door (UV treated)
shelves	Wooden shelves
lighting	White, amber and blue LED lighting
width	595 mm
height	1768 mm
depth	570 mm

DX-123.338DB



DX-123.338DSS



Technical support files



DUNAVOX Grande-143

A single zone, 143 bottles freestanding model from Dunavox's Grande range. Boasting an elegant exterior - the SS model has a stainless steel handle and the black unit has black handle. The DUNAVOX Grande-143 is perfect for contemporary kitchen environments, restaurants or hotels. The bottles are supported on patent display shelves and surrounded by white, amber and blue two-side LED lighting. Please note that this model is suitable for freestanding or built in use.

[1] COOLING ZONE	HANDLE DOOR	MULTI LED LIGHT	FREESTANDING	INTEGRATED	FAN ASSISTED COOLING
HUMIDITY CONTROL	UV LIGHT PROTECTION	VIBRATION FREE STORING	TOUCH SCREEN	143 BOTTLES	CHAMPAGNE & PROSECCO
+5°C +20°C	468 LITRE	108 KG	40 dB	3 YEARS WARRANTY	

door	Lock, reversible tinted glass door (UV treated)
shelves	Telescopic display shelves
lighting	White, amber and blue LED lighting
width	655 mm
height	1835 mm
depth	680 mm

DX-143.468B



DX-143.468SS



Technical support files

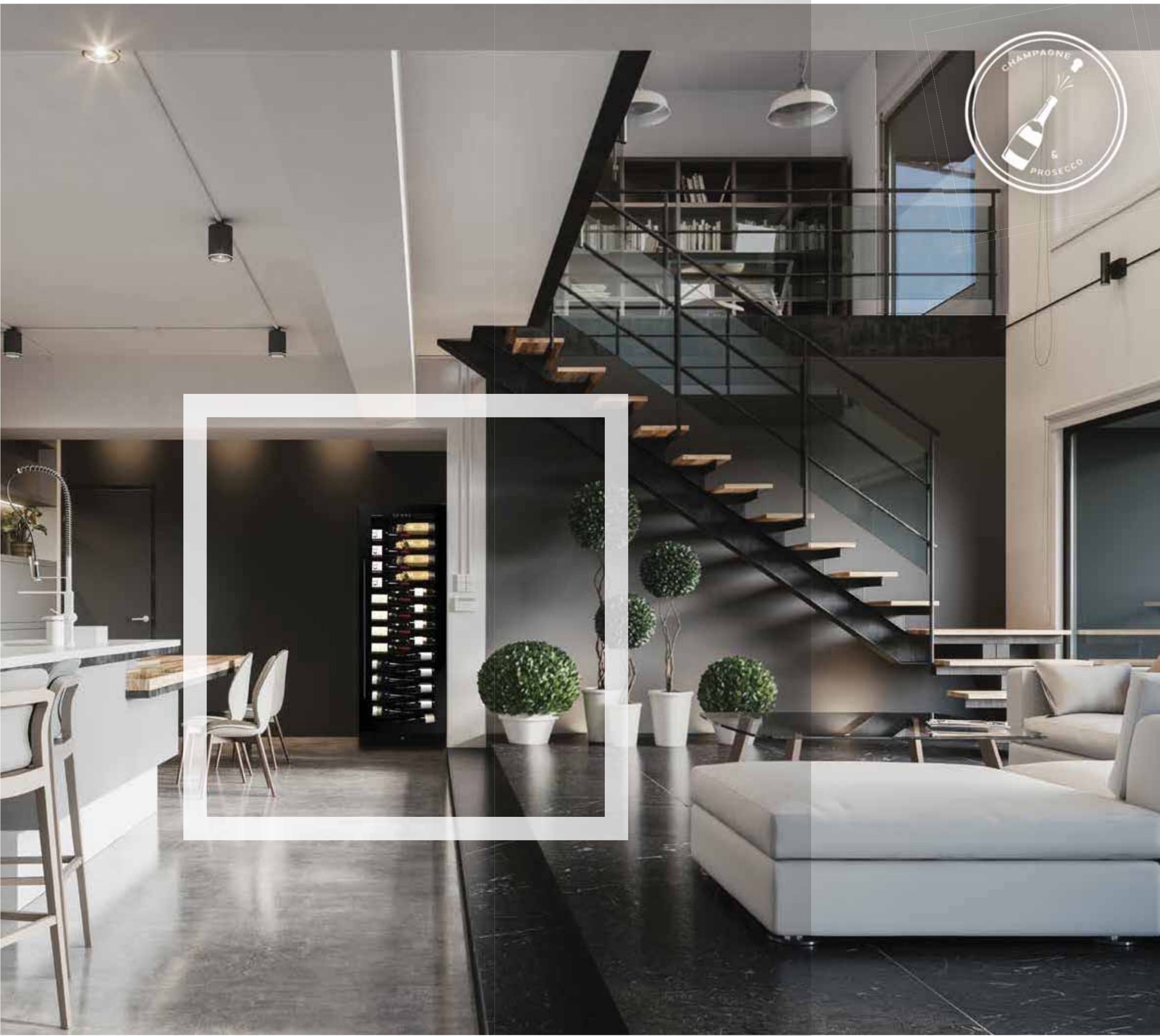

DUNAVOX Grande-166

A dual zone, 164 bottle freestanding model from Dunavox's Grande range. Boasting an elegant exterior - the DUNAVOX Grande-166 is perfect for contemporary kitchens, bars and hotels. The bottles are supported on wooden shelves set into a stunning light blue interior. The top zone must be colder than the lower zone. Please note that this model is suitable for freestanding or built in use.

[2] COOLING ZONES	HANDLE DOOR	INTERIOR LED LIGHT	FREESTANDING	INTEGRATED	FAN ASSISTED COOLING
HUMIDITY CONTROL	UV LIGHT PROTECTION	VIBRATION FREE STORING	TOUCH SCREEN	164 BOTTLES	+5 °C +12 °C +12 °C +20 °C
428 LITRE	102 KG	40 dB	3 YEARS WARRANTY		

door	Lock, reversible tinted glass door (UV treated)
shelves	Wooden shelves - telescopic
lighting	Blue interior LED lighting
width	595 mm
height	1770 mm
depth	680 mm

DX-166.428DBK



DX-166.428SDSK



Technical support files



DUNAVOX Grande-181

A dual zone, 181 bottle freestanding model from Dunavox's Grande range. Boasting an elegant exterior - The SDSK has a stainless steel handle and the black unit has a black handle. The DUNAVOX Grande-181 is perfect for contemporary kitchens, hotels and restaurants. The bottles are supported on wooden shelves set into a stunning light blue interior. The top zone must be colder than the lower zone. Please note that this model is suitable for freestanding or built in use.

[2] COOLING ZONES	HANDLE DOOR	INTERIOR LED LIGHT	FREESTANDING	INTEGRATED	FAN ASSISTED COOLING
HUMIDITY CONTROL	UV LIGHT PROTECTION	VIBRATION FREE STORING	TOUCH SCREEN	181 BOTTLES	+5 °C +12 °C +12 °C +20 °C
490 LITRE	108 KG	40 dB	3 YEARS WARRANTY		

door	Reversible tinted glass door (UV treated)
shelves	Wooden shelves - telescopic
lighting	Blue interior LED lighting
width	655 mm
height	1835 mm
depth	680 mm

DX-181.490DBK



DX-181.490SDSK



Technical support files



DUNAVOX Grande-194

A single zone, 183 bottles freestanding model from Dunavox's Grande range. Boasting an elegant exterior. The DUNAVOX Grande-194 is perfect for contemporary kitchens, hotels and restaurants. The bottles are supported on wooden shelves set into a stunning light blue interior. Please note that this model is suitable for freestanding and built in use.

[1] COOLING ZONE	HANDLE DOOR	INTERIOR LED LIGHT	FREESTANDING	INTEGRATED	FAN ASSISTED COOLING
HUMIDITY CONTROL	UV LIGHT PROTECTION	VIBRATION FREE STORING	TOUCH SCREEN	183 BOTTLES	+5°C +20°C
490 LITRE	108 KG	40 dB	3 YEARS WARRANTY		

door	Lock, reversible tinted glass door (UV treated)
shelves	Wooden shelves - telescopic
lighting	Blue interior LED lighting
width	655 mm
height	1835 mm
depth	680 mm

DX-194.490BK



DX-194.490SSK



Technical support files



MY THOUGHTS ABOUT WINE

A series of horizontal dashed lines for writing.



Product photos are illustrations. Models sold may be different.
Dunavox reserves the right to change parameters without prior notice.
Reproduction & printing: Millennium Csoport | www.millenniumcsoport.hu

www.dunavox.com

info@dunavox.com



www.facebook.com/dunavoxglobal



www.instagram.com/dunavoxglobal



www.linkedin.com/company/dunavox